

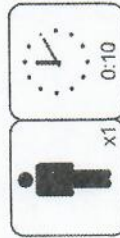

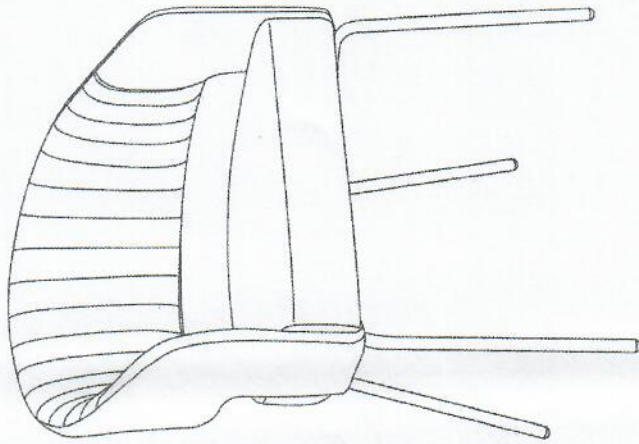

# ASSEMBLY INSTRUCTIONS

DINING CHAIR MODEL#: UDC8230

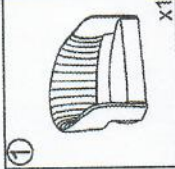
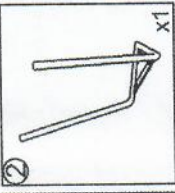
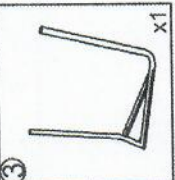

 ①	 ②	 ③	 A x6	 B x6	 C x1
---	---	---	--	--	--

1

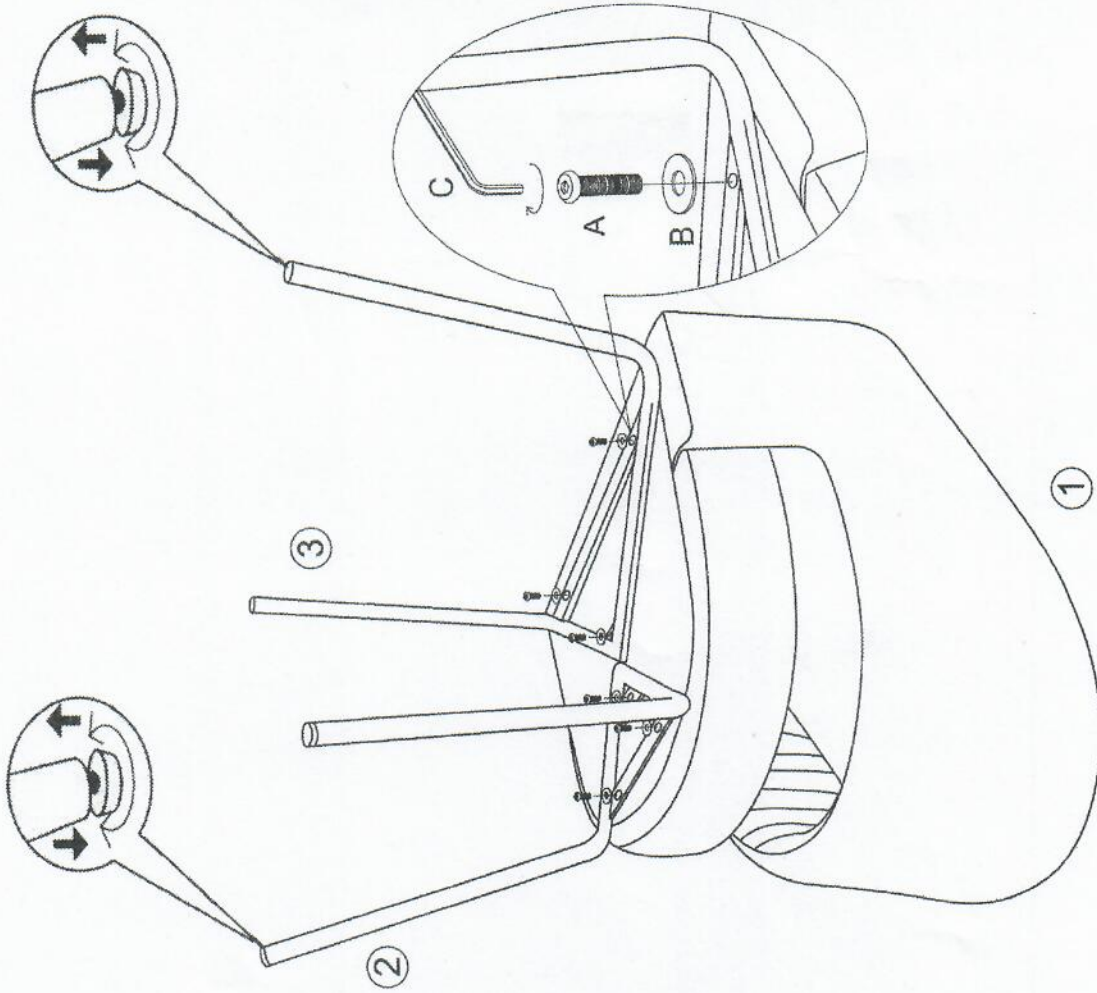

UCH-ARG 062412