

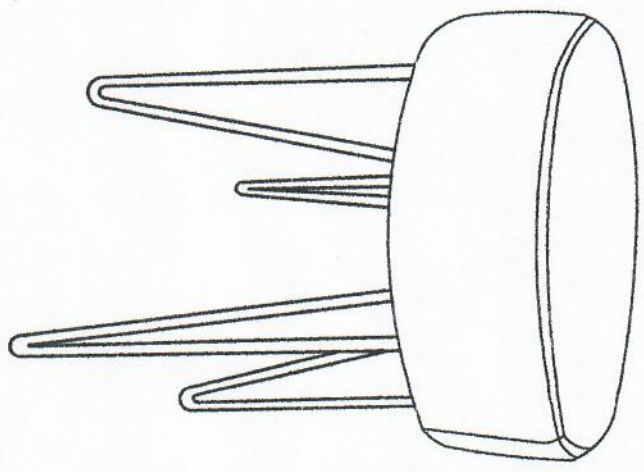

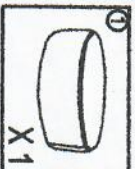



ASSEMBLY INSTRUCTIONS

MODEL #: UPF032

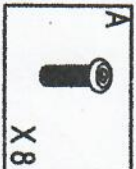

 ① X1	 ② X2
 A X8	 B X8
 C X1	

 X 1	 0:10
--	--

1

